

Part D	Problems 18–26 which require complete solutions.
Test time	120 minutes.
Resources	Digital resources, formula sheet and ruler.

Level requirements

The test consists of an oral part (Part A) and three written parts (Part B, Part C and Part D). Together they give a total of 67 consisting of 24 E-, 24 C- and 19 A-points.

Level requirements for test grades

E: 18 points

D: 27 points of which 8 points on at least C-level

C: 35 points of which 14 points on at least C-level

B: 45 points of which 6 points on A-level

A: 54 points of which 11 points on A-level

The number of points you can get for a complete solution is stated after each problem. You can also see what knowledge levels (E, C and A) you can show in each problem. For example (3/2/1) means that a correct solution gives 3 E-, 2 C- and 1 A-point.

For problems labelled “*Only answer is required*” you only have to give a short answer. For other problems you are required to present your solutions, explain and justify your train of thought and, where necessary, draw figures and show how you use your digital resources.

Write your name, date of birth and educational programme on all the sheets you hand in.

Name: _____

Date of birth: _____

Educational programme: _____

Part D: Digital resources are allowed. Write down your solutions on separate sheets of paper.

18. Find a value of the angle v so that the area of the triangle is 6.5 cm^2 . (2/0/0)

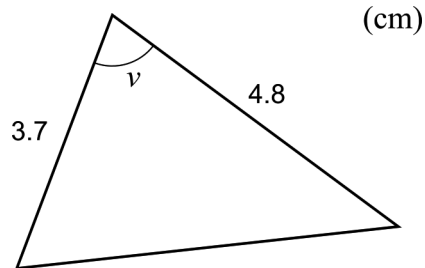

19. It holds for the function f that $f'(x) = 4x^3$
Determine $f(x)$ so that $f(5) = 282$ (2/0/0)

20. It holds for the function f that $f(x) = 4x^2 - x^4 + A$ where A is a constant. The figure shows the graph of the function f when $A = 0$

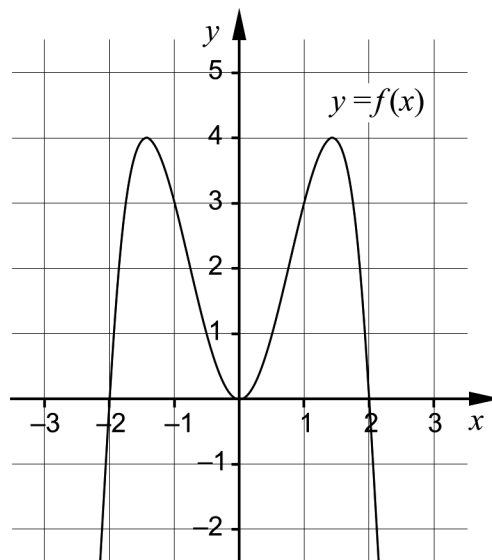

- a) Sabina claims:
– The function always has three extreme points, regardless of the value of the constant A .
Is Sabina right? Justify your answer. (1/0/0)
- b) Sabina investigates $f(x) = 4x^2 - x^4$ and claims:
– The second derivative of $f(x) = 4x^2 - x^4$ is less than 10 for all x .
Is Sabina right? Justify your answer. (0/1/0)

21. The society Lyckans IF wants to make a prognosis of the number of members for coming years. After studying the number of members during the last few years, they set up the model

$$f(t) = 1250e^{0.012t}$$

where $f(t)$ is the number of members and t is the time in years after January 1, 2010.

- a) Determine in what year the society has 2000 members according to the model. (2/0/0)
- b) Determine how fast the number of members increases on January 1, 2030 according to the model. (0/2/0)

There are also other models that describe the number of members as a function of time. One such model is

$$g(t) = 1250 + 16t$$

where $g(t)$ is the number of members and t is the time in years after January 1, 2010.

Lyckans IF wants to investigate how the prognosis for the number of members depends on which model they use. They will therefore investigate the difference in the number of members between the two models by using a new function.

- c) Write down the new function and use it to determine at what value of t the difference in the number of members is the largest within the interval $0 \leq t \leq 15$ (0/3/0)
22. Peder draws the graph of $f(x) = x^3 + 0.03x + 1$ on his graphic calculator and says:

–I see that there is a saddle point on the graph.

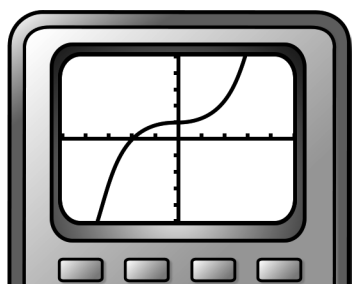

Investigate whether he is right. (0/2/0)

23. A land owner is going to determine the distance between two spots, marked A and B in the figure.

The land owner is at A but cannot see B due to the forest. From the two points C and D , which together with A lie on a straight line, she can see B . She measures angles and distances, see figure.

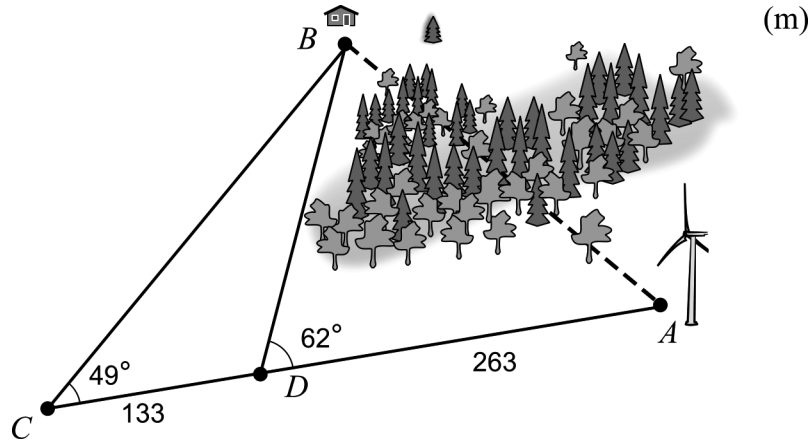

Calculate the distance AB .

(0/3/0)

24. The figure shows the graph of the function f .

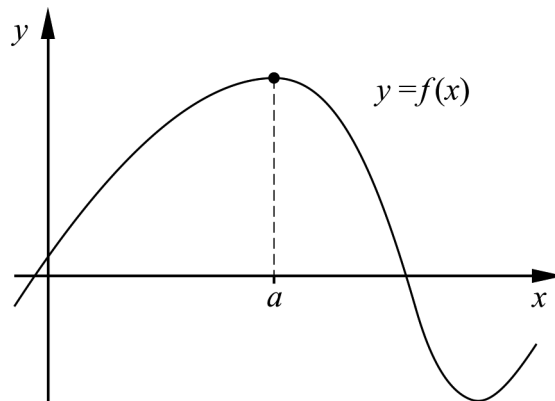

Use the figure and explain why the second derivative of the function is negative at the maximum point where $x = a$.

(0/0/2)

25. Prove the law of cosine $a^2 = b^2 + c^2 - 2bc \cos A$ for the case when the angle A is acute.

(0/0/2)

26. Amira is going to make concrete birdbaths. The birdbaths consist of four sides that will be mounted on a rectangular bottom plate. She wants the birdbaths to have a large enough bottom area and that the sides should not be too high. She therefore writes down the following conditions:

- The depth, from the upper rim to the bottom plate, must be 8 cm.
- The bottom plate must have a thickness of 4 cm.

See figure 1.

- One of the sides must be 6 cm thick.
- Three of the sides must be 4 cm thick.
- The bottom area, that is the area inside the birdbaths, must be 900 cm^2 .

See figure 2.

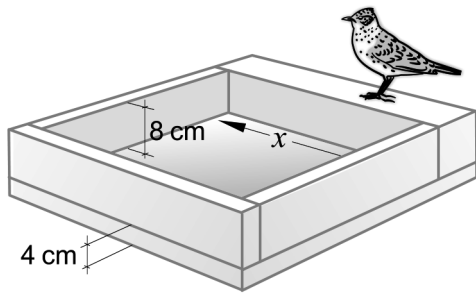

Figure 1.
A birdbath seen from the side.

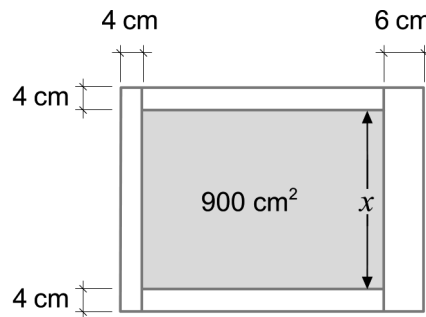

Figure 2.
A birdbath seen from above.

Amira wants to use as little concrete as possible and will therefore calculate how much concrete is needed for each birdbath. She assumes that one side of the bottom area is x cm. See figures above.

Write down a function that gives the volume of concrete as a function of x . Then use your function to determine the smallest volume of concrete Amira needs for each birdbath.

(0/0/4)